



LCM 16/85

100 Series Low Speed Pump

|| CHARACTERISTICS

- ◆ Pump with flexible neoprene impeller
- ◆ Low rotational speed
- ◆ Pump housing in 316L stainless steel, precision foundry
- ◆ Flows: 16 to 85 hl/ h
- ◆ Speed: 230 to 460 rpm
- ◆ Pump on stainless steel trolley
- ◆ Low oxygen dissolution (<0,05mg/L)
- ◆ Direction reversal switch
- ◆ Power : 1,2 kW



- ◆ Pumping over
- ◆ Filtration
- ◆ Bottling
- ◆ Descaling
- ◆ Barrel filing

|| PRESSURE/FLOW

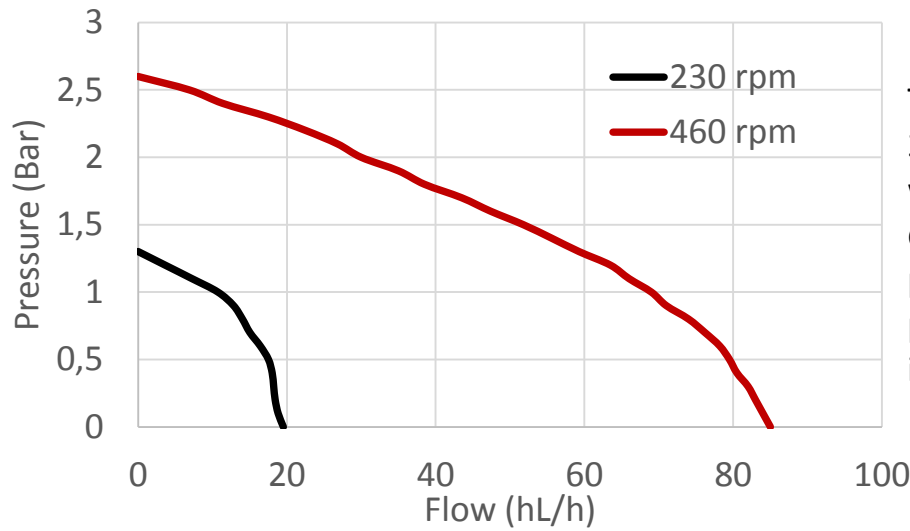

This test was carried out with a 3 meter pipe Ø50, with 15°C water. Pressure losses can be different, depending of the pipe, the characteristics of the product conveyed and the impeller.

|| OVERALL DIMENSIONS

Weight : 46kg

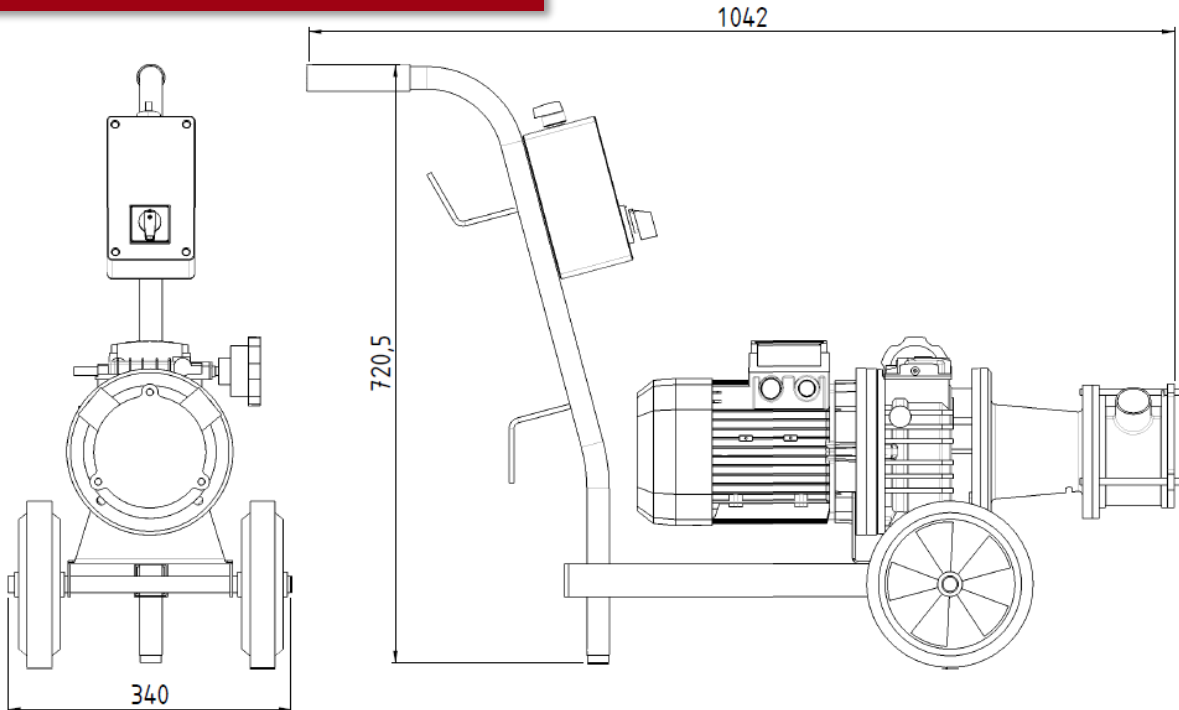

Non-contractual document.

CAZAUX - ZA de Lalande - Route de Lalande - 33450 Montussan - France

Phone : +33 5 57 77 70 70 - Fax : +33 5 57 77 70 79

Email : commercial@rotorflex.com – Website : www.rotorflex.com

